

25C D ■ 8235605 0004066 9 ■ SIEG
 PNP Germanium RF Transistor 25C 04066 D AF 239
 SIEMENS AKTIENGESELLSCHAFT ————— T-31-07

for UHF input stages up to 900 MHz

AF 239 is a germanium PNP mesa transistor in TO 72 case (18 A 4 DIN 41876). The leads are electrically insulated from the case.

Type	Ordering code
AF 239	Q60106-X239

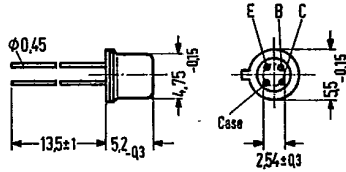

Approx. weight 0.4 g Dimensions in mm

Maximum ratings

Collector-emitter voltage	$-V_{CEO}$	15	V
Collector-emitter voltage	$-V_{CES}$	20	V
Emitter-base voltage	$-V_{EBO}$	0.3	V
Collector current	$-I_C$	10	mA
Emitter current	I_E	11	mA
Base current	$-I_B$	1	mA
Junction temperature	T_j	90	°C
Storage temperature range	T_{stg}	-30 to +75	°C
Total power dissipation ($T_{amb} = 45^\circ\text{C}$)	P_{tot}	60	mW

Thermal resistance

Junction to ambient air	R_{thJA}	≤ 750	K/W
Junction to case	R_{thJC}	≤ 400	K/W

Static characteristics ($T_{amb} = 25^\circ\text{C}$)

For the operating point, the following data applies:

$-V_{CE}$ V	$-I_C$ mA	$-I_B$ μA	h_{FE} I_C/I_B	$-V_{BE}$ mV
10	2	40	50 (>10)	350
5	5	120	42	400

Collector cutoff current ($-V_{CES} = 20\text{ V}$)	$-I_{CES}$	0.5 (<8)	μA
Collector cutoff current ($-V_{CEO} = 15\text{ V}$)	$-I_{CEO}$	< 500	μA
Emitter cutoff current ($-V_{EBO} = 0.3\text{ V}$)	$-I_{EBO}$	< 100	μA

Dynamic characteristics ($T_{amb} = 25^{\circ}\text{C}$)

Transition frequency ($-I_C = 2\text{ mA}; -V_{CE} = 10\text{ V}; f = 100\text{ MHz}$)	f_T	700	MHz
Reverse transfer capacitance ($-I_C = 2\text{ mA}; -V_{CE} = 10\text{ V}; f = 450\text{ kHz}$)	$-C_{12e}$	0.23	pF

Operating point: $-I_C = 2\text{ mA}; -V_{CB} = 10\text{ V}$

Power gain (common base configuration)

($f = 800\text{ MHz}; R_L = 500\ \Omega$)	G_{pb}	11.5 (>9)	dB
($f = 800\text{ MHz}; R_L = 2\text{ k}\Omega$)	G_{pb}	14.5 (>11.5)	dB
($f = 900\text{ MHz}; R_L = 500\ \Omega$)	G_{pb}	10.5 (≥ 8.5)	dB
($f = 900\text{ MHz}; R_L = 2\text{ k}\Omega$)	G_{pb}	12.5	dB
Noise figure			
($f = 800\text{ MHz}; R_g = 60\ \Omega$)	NF	5 (<6)	dB
($f = 900\text{ MHz}; R_g = 60\ \Omega$)	NF	6 (<7)	dB

Four-pole characteristics ($-I_C = 2\text{ mA}; -V_{CE} = 10\text{ V};$ measuring plane 5 mm below case bottom) $f = 200\text{ MHz}$

$g_{11b} = 45\text{ mS}$	$ Y_{12b} = 0.09\text{ mS}$	$ Y_{21b} = 52\text{ mS}$	$g_{22b} = 0.05\text{ mS}$
$-b_{11b} = 29\text{ mS}$	$\varphi_{12b} = -90^{\circ}$	$\varphi_{21b} = 135^{\circ}$	$b_{22b} = 1.6\text{ mS}$

$f = 800\text{ MHz}$

$g_{11b} = 2\text{ mS}$	$ Y_{12b} = 0.38\text{ mS}$	$ Y_{21b} = 20\text{ mS}$	$g_{22b} = 0.5\text{ mS}$
$-b_{11b} = 17.5\text{ mS}$	$\varphi_{12b} = -100^{\circ}$	$\varphi_{21b} = 37^{\circ}$	$b_{22b} = 6.3\text{ mS}$

Test circuit for power gain and noise figure at $f = 800\text{ MHz}$

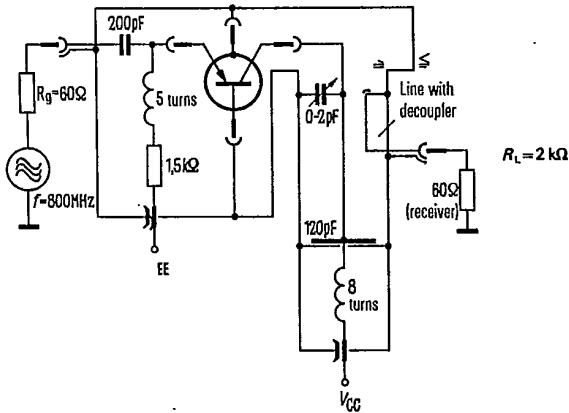

Total perm. power dissipation versus temperature
 $P_{tot} = f(T)$; R_{th} = parameter

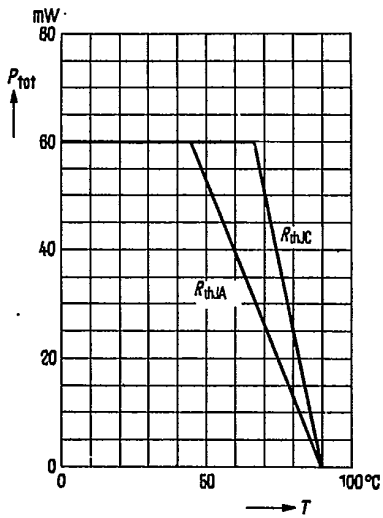

Collector cutoff current versus temperature $I_{CBO} = f(T_{amb})$
 $-V_{CBO} = 20 V$

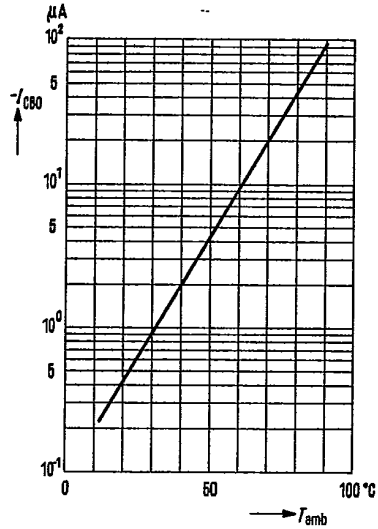

Collector current $I_C = f(I_B)$
 $V_{CE} = \text{parameter}$
 (common emitter configuration)

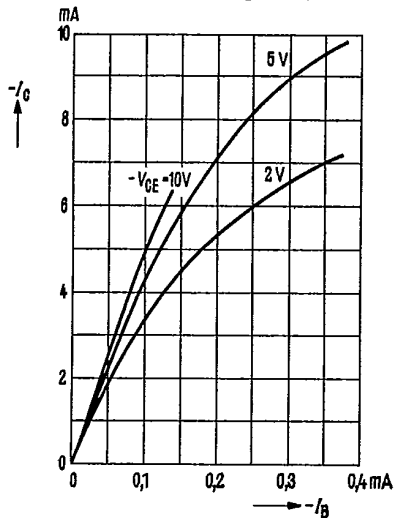

Collector current $I_C = f(V_{BE})$
 $V_{CE} = \text{parameter}$
 (common emitter configuration)

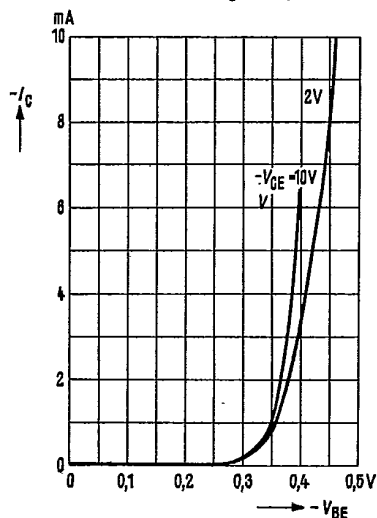

T-31-07

Output characteristics $I_C = f(V_{CE})$
 $I_B = \text{parameter}$
 (common emitter configuration)

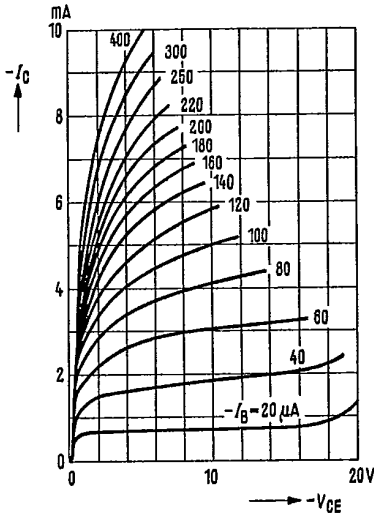

Output characteristics $I_C = f(V_{CB})$
 $I_E = \text{parameter}$
 (common base configuration)

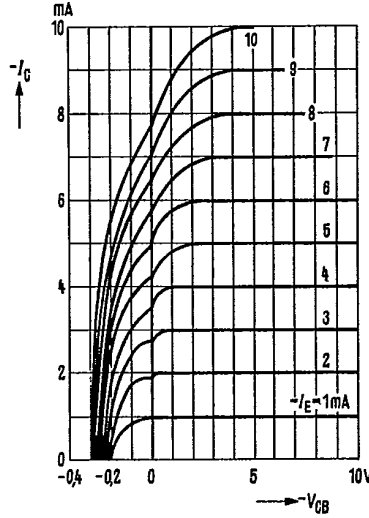

Transition frequency $f_T = f(I_C)$
 $-V_{CE} = 10 \text{ V}; f = 100 \text{ MHz}$

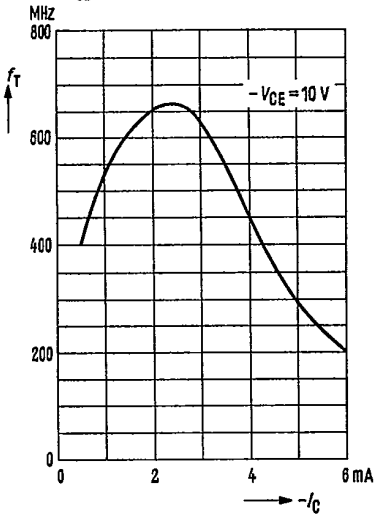

Power gain $G_{pb} = f(I_C)$
 $f = 600 \text{ MHz}; -V_{CE} = 10 \text{ V};$
 $R_V = 1 \text{ k}\Omega; R_L = 2 \text{ k}\Omega$
 (common base configuration)

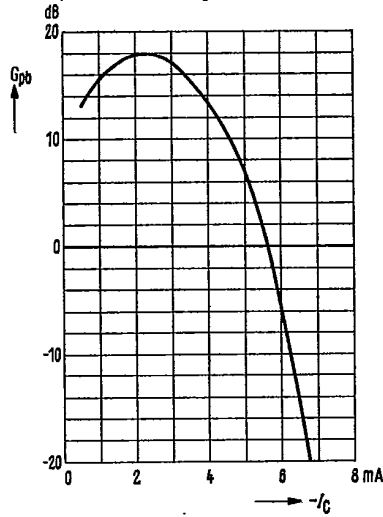

T-31-07

Power gain $G_{pb} = f(I_C)$
 $f = 800 \text{ MHz}$; $-V_{\text{batt}} = 10 \text{ V}$; $R_V = 1 \text{ k}\Omega$;
 $R_L = 500 \Omega$
 (common base configuration)

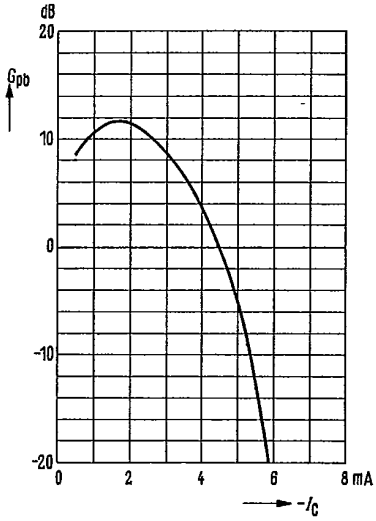

Power gain $G_{pb} = f(I_C)$
 $f = 800 \text{ MHz}$; $-V_{\text{batt}} = 10 \text{ V}$
 $R_V = 1 \text{ k}\Omega$; $R_L = 2 \text{ k}\Omega$
 (common base configuration)

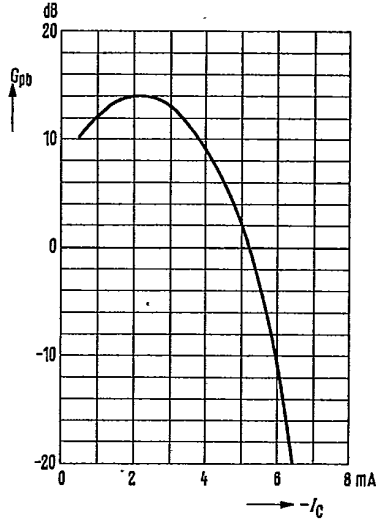

Noise figure versus frequency $NF = f(f)$
 $-V_{CB} = 10 \text{ V}$;
 $-I_C = 2 \text{ mA}$; $R_G = 60 \Omega$

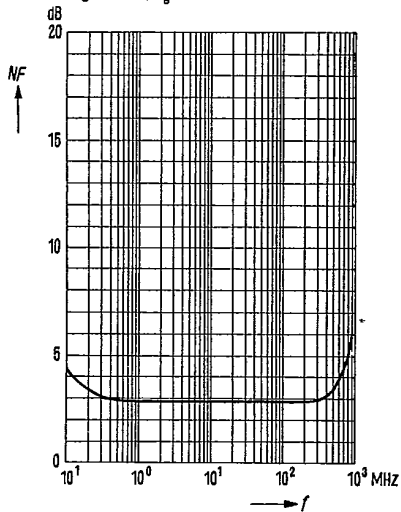

T-31-07

Small signal short circuit input admittance y_{11b} ; $-V_{CB} = 10\text{ V}$
 (common base configuration)
 measuring plane 5 mm below case bottom

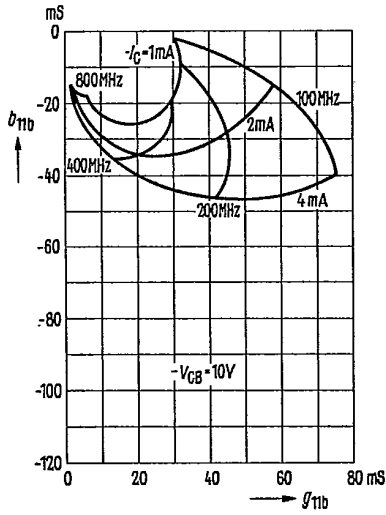

Small signal circuit reverse transfer admittance y_{12b} ; $-V_{CB} = 10\text{ V}$
 (common base configuration)
 measuring plane 5 mm below case bottom

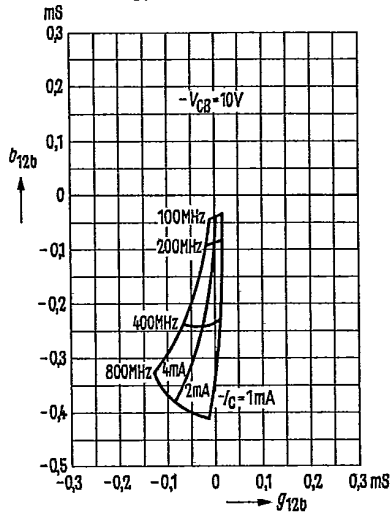

Small signal short circuit forward transfer admittance y_{21b} ; $-V_{CB} = 10\text{ V}$
 (common base configuration)
 measuring plane 5 mm below case bottom

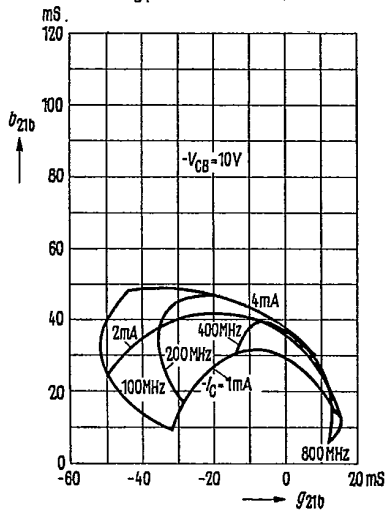

Small signal short circuit output admittance y_{22b} ; $-V_{CB} = 10\text{ V}$
 (common base configuration)
 measuring plane 5 mm below case bottom

