

# DATA SHEET

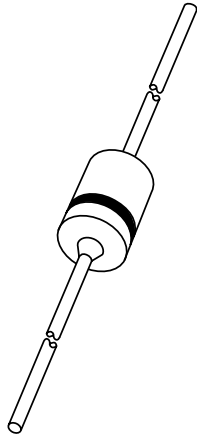

## **BZX79 series** Voltage regulator diodes

Product data sheet  
Supersedes data of 1999 May 25

2002 Feb 27

# Voltage regulator diodes

# BZX79 series

## FEATURES

- Total power dissipation: max. 500 mW
- Two tolerance series:  $\pm 2\%$ , and approx.  $\pm 5\%$
- Working voltage range: nom. 2.4 to 75 V (E24 range)
- Non-repetitive peak reverse power dissipation: max. 40 W.

## APPLICATIONS

- Low voltage stabilizers or voltage references.

## DESCRIPTION

Low-power voltage regulator diodes in hermetically sealed leaded glass SOD27 (DO-35) packages. The diodes are available in the normalized E24  $\pm 2\%$  (BZX79-B) and approx.  $\pm 5\%$  (BZX79-C) tolerance range. The series consists of 37 types with nominal working voltages from 2.4 to 75 V.

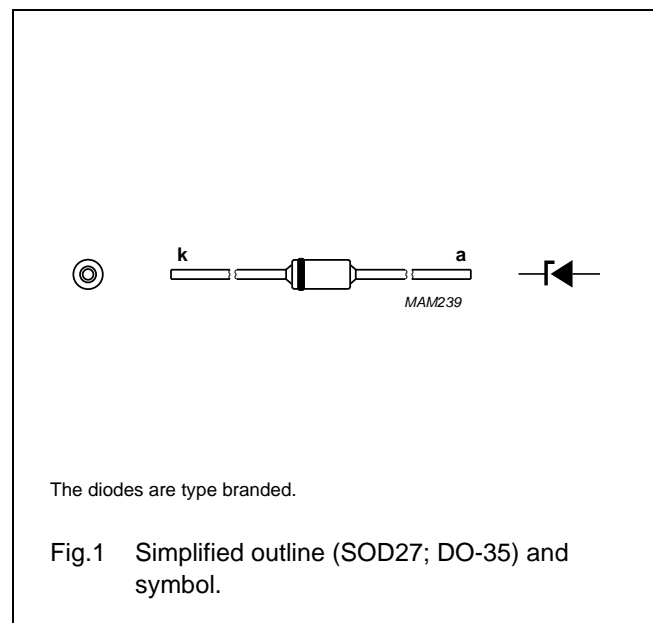

## LIMITING VALUES

In accordance with the Absolute Maximum Rating System (IEC 60134).

SYMBOL	PARAMETER	CONDITIONS	MIN.	MAX.	UNIT
$I_F$	continuous forward current		–	250	mA
$I_{ZSM}$	non-repetitive peak reverse current	$t_p = 100 \mu s$ ; square wave; $T_j = 25 \text{ }^\circ\text{C}$ prior to surge	see Tables 1 and 2		A
$P_{tot}$	total power dissipation	$T_{amb} = 50 \text{ }^\circ\text{C}$ ; note 1	–	400	mW
		$T_{amb} = 50 \text{ }^\circ\text{C}$ ; note 2	–	500	mW
$P_{ZSM}$	non-repetitive peak reverse power dissipation	$t_p = 100 \mu s$ ; square wave; $T_j = 25 \text{ }^\circ\text{C}$ prior to surge; see Fig.3	–	40	W
$T_{stg}$	storage temperature		–65	+200	$^\circ\text{C}$
$T_j$	junction temperature		–65	+200	$^\circ\text{C}$

## Notes

1. Device mounted on a printed circuit-board without metallization pad; lead length max.
2. Tie-point temperature  $\leq 50 \text{ }^\circ\text{C}$ ; max. lead length 8 mm.

## ELECTRICAL CHARACTERISTICS

### Total BZX79-B and BZX79-C series

$T_j = 25 \text{ }^\circ\text{C}$  unless otherwise specified.

SYMBOL	PARAMETER	CONDITIONS	MAX.	UNIT
$V_F$	forward voltage	$I_F = 10 \text{ mA}$ ; see Fig.4	0.9	V

## Voltage regulator diodes

## BZX79 series

SYMBOL	PARAMETER	CONDITIONS	MAX.	UNIT
$I_R$	reverse current			
	BZX79-B/C2V4	$V_R = 1\text{ V}$	50	$\mu\text{A}$
	BZX79-B/C2V7	$V_R = 1\text{ V}$	20	$\mu\text{A}$
	BZX79-B/C3V0	$V_R = 1\text{ V}$	10	$\mu\text{A}$
	BZX79-B/C3V3	$V_R = 1\text{ V}$	5	$\mu\text{A}$
	BZX79-B/C3V6	$V_R = 1\text{ V}$	5	$\mu\text{A}$
	BZX79-B/C3V9	$V_R = 1\text{ V}$	3	$\mu\text{A}$
	BZX79-B/C4V3	$V_R = 1\text{ V}$	3	$\mu\text{A}$
	BZX79-B/C4V7	$V_R = 2\text{ V}$	3	$\mu\text{A}$
	BZX79-B/C5V1	$V_R = 2\text{ V}$	2	$\mu\text{A}$
	BZX79-B/C5V6	$V_R = 2\text{ V}$	1	$\mu\text{A}$
	BZX79-B/C6V2	$V_R = 4\text{ V}$	3	$\mu\text{A}$
	BZX79-B/C6V8	$V_R = 4\text{ V}$	2	$\mu\text{A}$
	BZX79-B/C7V5	$V_R = 5\text{ V}$	1	$\mu\text{A}$
	BZX79-B/C8V2	$V_R = 5\text{ V}$	700	$\text{nA}$
	BZX79-B/C9V1	$V_R = 6\text{ V}$	500	$\text{nA}$
	BZX79-B/C10	$V_R = 7\text{ V}$	200	$\text{nA}$
	BZX79-B/C11	$V_R = 8\text{ V}$	100	$\text{nA}$
	BZX79-B/C12	$V_R = 8\text{ V}$	100	$\text{nA}$
BZX79-B/C13	$V_R = 8\text{ V}$	100	$\text{nA}$	
BZX79-B/C15 to BZX79-B/C75	$V_R = 0.7V_{Znom}$	50	$\text{nA}$	

## Voltage regulator diodes

## BZX79 series

**Table 1** Per type, BZX79-B/C2V4 to BZX79-B/C24 $T_j = 25\text{ °C}$  unless otherwise specified.

BZX79- Bxxx Cxxx	WORKING VOLTAGE $V_z$ (V) at $I_{ztest} = 5\text{ mA}$				DIFFERENTIAL RESISTANCE $r_{dif}$ ( $\Omega$ )				TEMP. COEFF. $S_z$ (mV/K) at $I_{ztest} = 5\text{ mA}$ (see Figs 5 and 6)			DIODE CAP. $C_d$ (pF) at $f = 1\text{ MHz}$ ; $V_R = 0\text{ V}$	NON-REPETITIVE PEAK REVERSE CURRENT $I_{zSM}$ (A) at $t_p = 100\text{ }\mu\text{s}$ ; $T_{amb} = 25\text{ °C}$
	Tol. $\pm 2\%$ (B)		Tol. approx. $\pm 5\%$ (C)		at $I_{ztest} = 1\text{ mA}$		at $I_{ztest} = 5\text{ mA}$		MIN.	TYP.	MAX.	MAX.	MAX.
	MIN.	MAX.	MIN.	MAX.	TYP.	MAX.	TYP.	MAX.					
2V4	2.35	2.45	2.2	2.6	275	600	70	100	-3.5	-1.6	0	450	6.0
2V7	2.65	2.75	2.5	2.9	300	600	75	100	-3.5	-2.0	0	450	6.0
3V0	2.94	3.06	2.8	3.2	325	600	80	95	-3.5	-2.1	0	450	6.0
3V3	3.23	3.37	3.1	3.5	350	600	85	95	-3.5	-2.4	0	450	6.0
3V6	3.53	3.67	3.4	3.8	375	600	85	90	-3.5	-2.4	0	450	6.0
3V9	3.82	3.98	3.7	4.1	400	600	85	90	-3.5	-2.5	0	450	6.0
4V3	4.21	4.39	4.0	4.6	410	600	80	90	-3.5	-2.5	0	450	6.0
4V7	4.61	4.79	4.4	5.0	425	500	50	80	-3.5	-1.4	0.2	300	6.0
5V1	5.00	5.20	4.8	5.4	400	480	40	60	-2.7	-0.8	1.2	300	6.0
5V6	5.49	5.71	5.2	6.0	80	400	15	40	-2.0	1.2	2.5	300	6.0
6V2	6.08	6.32	5.8	6.6	40	150	6	10	0.4	2.3	3.7	200	6.0
6V8	6.66	6.94	6.4	7.2	30	80	6	15	1.2	3.0	4.5	200	6.0
7V5	7.35	7.65	7.0	7.9	30	80	6	15	2.5	4.0	5.3	150	4.0
8V2	8.04	8.36	7.7	8.7	40	80	6	15	3.2	4.6	6.2	150	4.0
9V1	8.92	9.28	8.5	9.6	40	100	6	15	3.8	5.5	7.0	150	3.0
10	9.80	10.20	9.4	10.6	50	150	8	20	4.5	6.4	8.0	90	3.0
11	10.80	11.20	10.4	11.6	50	150	10	20	5.4	7.4	9.0	85	2.5
12	11.80	12.20	11.4	12.7	50	150	10	25	6.0	8.4	10.0	85	2.5
13	12.70	13.30	12.4	14.1	50	170	10	30	7.0	9.4	11.0	80	2.5
15	14.70	15.30	13.8	15.6	50	200	10	30	9.2	11.4	13.0	75	2.0
16	15.70	16.30	15.3	17.1	50	200	10	40	10.4	12.4	14.0	75	1.5
18	17.60	18.40	16.8	19.1	50	225	10	45	12.4	14.4	16.0	70	1.5
20	19.60	20.40	18.8	21.2	60	225	15	55	12.3	15.6	18.0	60	1.5
22	21.60	22.40	20.8	23.3	60	250	20	55	14.1	17.6	20.0	60	1.25
24	23.50	24.50	22.8	25.6	60	250	25	70	15.9	19.6	22.0	55	1.25

## Voltage regulator diodes

## BZX79 series

**Table 2** Per type, BZX79-B/C27 to BZX79-B/C75 $T_j = 25\text{ °C}$  unless otherwise specified.

BZX79- Bxxx Cxxx	WORKING VOLTAGE $V_z$ (V) at $I_{z\text{test}} = 2\text{ mA}$				DIFFERENTIAL RESISTANCE $r_{\text{dif}}$ ( $\Omega$ )				TEMP. COEFF. $S_z$ (mV/K) at $I_{z\text{test}} = 2\text{ mA}$ (see Figs 5 and 6)			DIODE CAP. $C_d$ (pF) at $f = 1\text{ MHz}$ ; $V_R = 0\text{ V}$	NON-REPETITIVE PEAK REVERSE CURRENT $I_{z\text{SM}}$ (A) at $t_p = 100\text{ }\mu\text{s}$ ; $T_{\text{amb}} = 25\text{ °C}$
	Tol. $\pm 2\%$ (B)		Tol. approx. $\pm 5\%$ (C)		at $I_{z\text{test}} = 0.5\text{ mA}$		at $I_{z\text{test}} = 2\text{ mA}$		MIN.	TYP.	MAX.	MAX.	MAX.
	MIN.	MAX.	MIN.	MAX.	TYP.	MAX.	TYP.	MAX.					
27	26.50	27.50	25.1	28.9	65	300	25	80	18.0	22.7	25.3	50	1.0
30	29.40	30.60	28.0	32.0	70	300	30	80	20.6	25.7	29.4	50	1.0
33	32.30	33.70	31.0	35.0	75	325	35	80	23.3	28.7	33.4	45	0.9
36	35.30	36.70	34.0	38.0	80	350	35	90	26.0	31.8	37.4	45	0.8
39	38.20	39.80	37.0	41.0	80	350	40	130	28.7	34.8	41.2	45	0.7
43	42.10	43.90	40.0	46.0	85	375	45	150	31.4	38.8	46.6	40	0.6
47	46.10	47.90	44.0	50.0	85	375	50	170	35.0	42.9	51.8	40	0.5
51	50.00	52.00	48.0	54.0	90	400	60	180	38.6	46.9	57.2	40	0.4
56	54.90	57.10	52.0	60.0	100	425	70	200	42.2	52.0	63.8	40	0.3
62	60.80	63.20	58.0	66.0	120	450	80	215	58.8	64.4	71.6	35	0.3
68	66.60	69.40	64.0	72.0	150	475	90	240	65.6	71.7	79.8	35	0.25
75	73.50	76.50	70.0	79.0	170	500	95	255	73.4	80.2	88.6	35	0.2

# Voltage regulator diodes

# BZX79 series

## THERMAL CHARACTERISTICS

SYMBOL	PARAMETER	CONDITIONS	VALUE	UNIT
$R_{th\ j-tp}$	thermal resistance from junction to tie-point	lead length 8 mm.	300	K/W
$R_{th\ j-a}$	thermal resistance from junction to ambient	lead length max.; see Fig.2 and note 1	380	K/W

### Note

1. Device mounted on a printed circuit-board without metallization pad.

## GRAPHICAL DATA

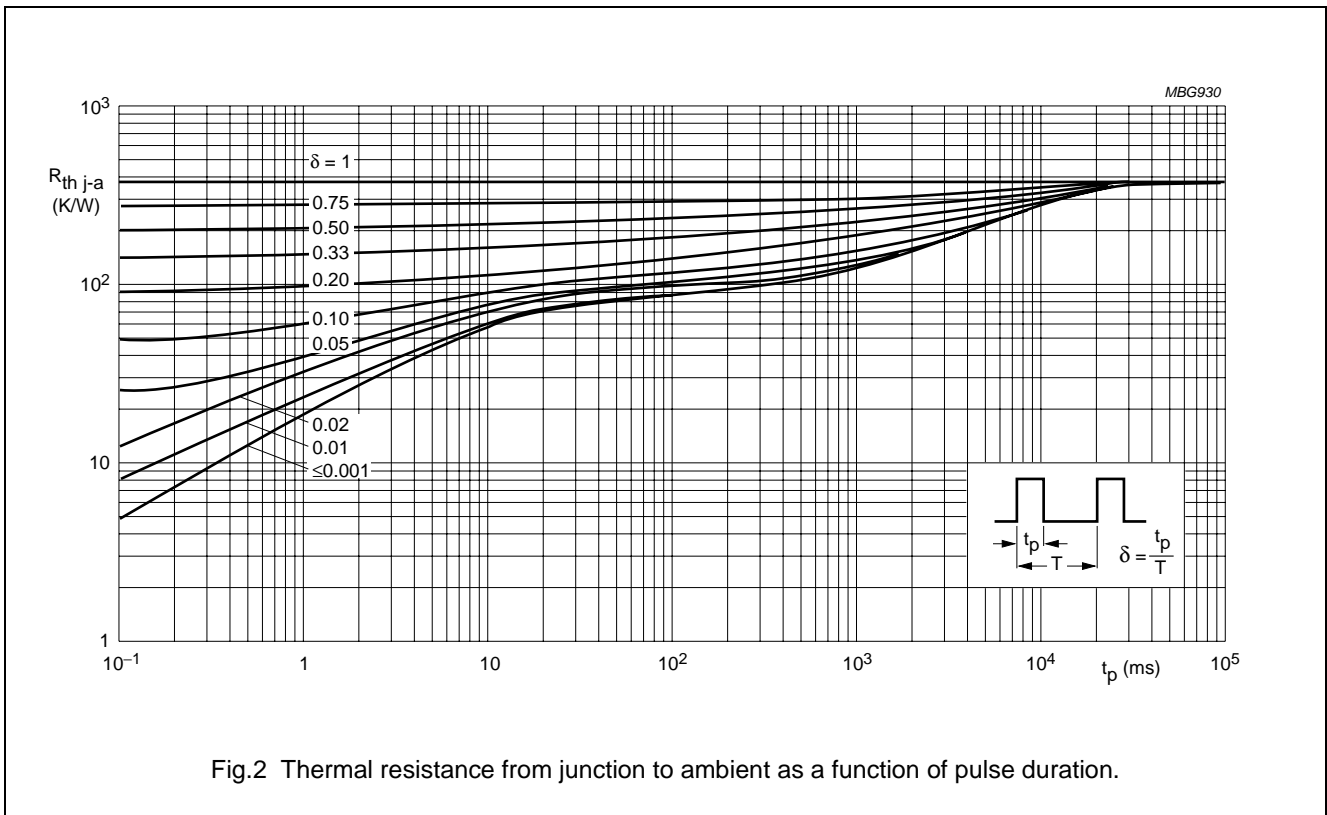
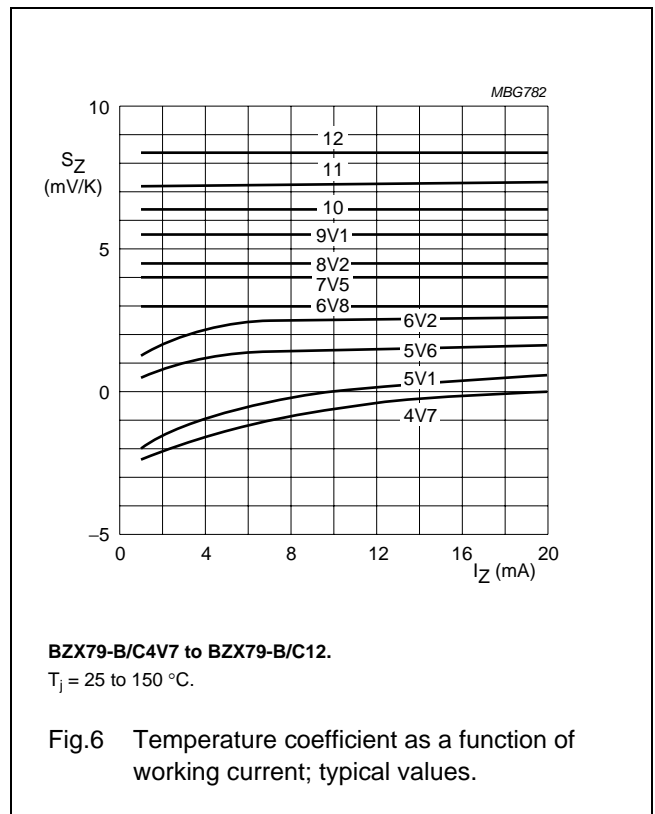
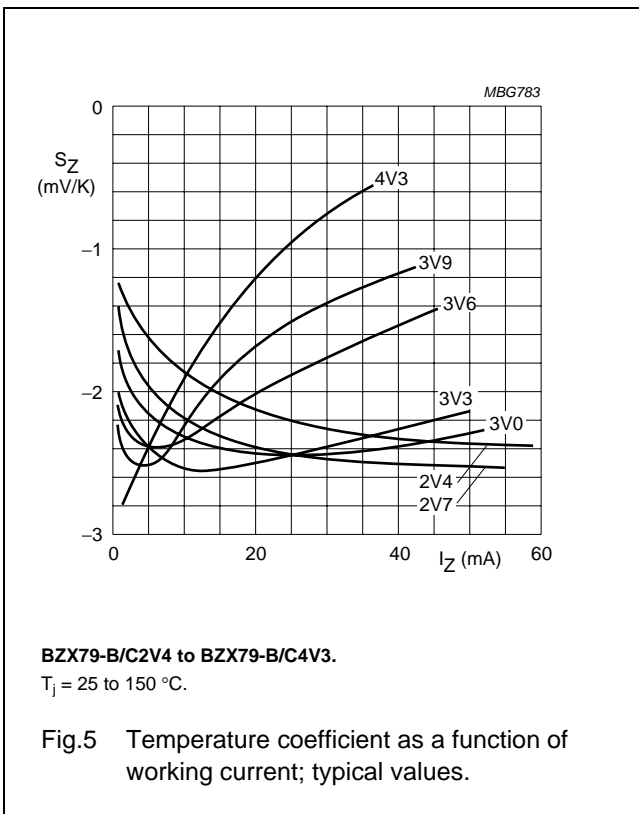
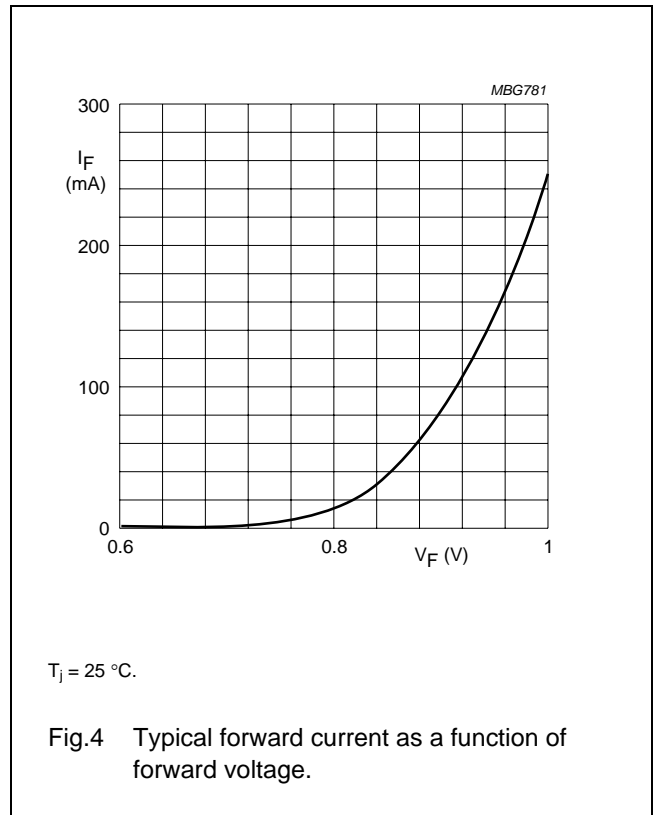
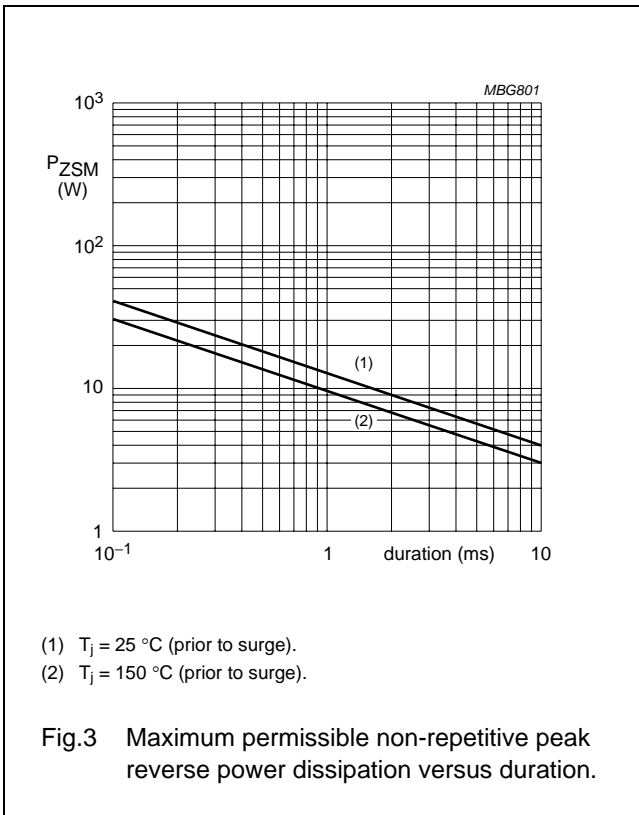

Fig.2 Thermal resistance from junction to ambient as a function of pulse duration.

Voltage regulator diodes

BZX79 series



Voltage regulator diodes

BZX79 series

PACKAGE OUTLINE

Hermetically sealed glass package; axial leaded; 2 leads

SOD27

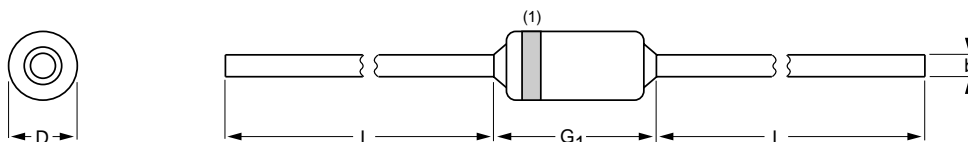

DIMENSIONS (mm are the original dimensions)

UNIT	b max.	D max.	G <sub>1</sub> max.	L min.
mm	0.56	1.85	4.25	25.4



Note

1. The marking band indicates the cathode.

OUTLINE VERSION	REFERENCES				EUROPEAN PROJECTION	ISSUE DATE
	IEC	JEDEC	EIAJ			
SOD27	A24	DO-35	SC-40			97-06-09



Voltage regulator diodes

BZX79 series

**DATA SHEET STATUS**

DOCUMENT STATUS <sup>(1)</sup>	PRODUCT STATUS <sup>(2)</sup>	DEFINITION
Objective data sheet	Development	This document contains data from the objective specification for product development.
Preliminary data sheet	Qualification	This document contains data from the preliminary specification.
Product data sheet	Production	This document contains the product specification.

**Notes**

1. Please consult the most recently issued document before initiating or completing a design.
2. The product status of device(s) described in this document may have changed since this document was published and may differ in case of multiple devices. The latest product status information is available on the Internet at URL <http://www.nxp.com>.

**DISCLAIMERS**

**General** — Information in this document is believed to be accurate and reliable. However, NXP Semiconductors does not give any representations or warranties, expressed or implied, as to the accuracy or completeness of such information and shall have no liability for the consequences of use of such information.

**Right to make changes** — NXP Semiconductors reserves the right to make changes to information published in this document, including without limitation specifications and product descriptions, at any time and without notice. This document supersedes and replaces all information supplied prior to the publication hereof.

**Suitability for use** — NXP Semiconductors products are not designed, authorized or warranted to be suitable for use in medical, military, aircraft, space or life support equipment, nor in applications where failure or malfunction of an NXP Semiconductors product can reasonably be expected to result in personal injury, death or severe property or environmental damage. NXP Semiconductors accepts no liability for inclusion and/or use of NXP Semiconductors products in such equipment or applications and therefore such inclusion and/or use is at the customer's own risk.

**Applications** — Applications that are described herein for any of these products are for illustrative purposes only. NXP Semiconductors makes no representation or warranty that such applications will be suitable for the specified use without further testing or modification.

**Limiting values** — Stress above one or more limiting values (as defined in the Absolute Maximum Ratings System of IEC 60134) may cause permanent damage to the device. Limiting values are stress ratings only and operation of the device at these or any other conditions

above those given in the Characteristics sections of this document is not implied. Exposure to limiting values for extended periods may affect device reliability.

**Terms and conditions of sale** — NXP Semiconductors products are sold subject to the general terms and conditions of commercial sale, as published at <http://www.nxp.com/profile/terms>, including those pertaining to warranty, intellectual property rights infringement and limitation of liability, unless explicitly otherwise agreed to in writing by NXP Semiconductors. In case of any inconsistency or conflict between information in this document and such terms and conditions, the latter will prevail.

**No offer to sell or license** — Nothing in this document may be interpreted or construed as an offer to sell products that is open for acceptance or the grant, conveyance or implication of any license under any copyrights, patents or other industrial or intellectual property rights.

**Export control** — This document as well as the item(s) described herein may be subject to export control regulations. Export might require a prior authorization from national authorities.

**Quick reference data** — The Quick reference data is an extract of the product data given in the Limiting values and Characteristics sections of this document, and as such is not complete, exhaustive or legally binding.

# ***NXP Semiconductors***

## **Customer notification**

This data sheet was changed to reflect the new company name NXP Semiconductors. No changes were made to the content, except for the legal definitions and disclaimers.

## **Contact information**

For additional information please visit: **<http://www.nxp.com>**

For sales offices addresses send e-mail to: **[salesaddresses@nxp.com](mailto:salesaddresses@nxp.com)**

© NXP B.V. 2009

All rights are reserved. Reproduction in whole or in part is prohibited without the prior written consent of the copyright owner.

The information presented in this document does not form part of any quotation or contract, is believed to be accurate and reliable and may be changed without notice. No liability will be accepted by the publisher for any consequence of its use. Publication thereof does not convey nor imply any license under patent- or other industrial or intellectual property rights.

Printed in The Netherlands

613514/03/pp10

Date of release: 2002 Feb 27

Document order number: 9397 750 09387

