

# HA1377

## Dual 5.8W Audio Power Amplifiers

This audio power IC is specifically designed for car stereo amplifiers encapsulated in 12-lead single-in-line plastic package.

This IC provides an output power of 5.8 watts per channel under the condition of 4 ohm loaded, 10 percent distortion and 13.2 volt power supply.

### ■ FEATURES

- Easy to mount a chassis by heat-sink, due to the single-in-line package with no electrical isolation.
- Overvoltage handling capability up to 50 volts for 200 msec pulse duration.
- Thermal shut-down circuit included.
- Less number of external components.

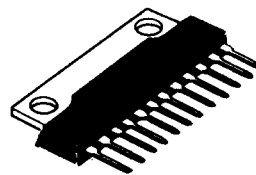

(SP-12T)

### ■ ABSOLUTE MAXIMUM RATINGS ( $T_a = 25^\circ\text{C}$ )

Item	Symbol	Ratings	Unit	Notes
Operating Supply Voltage	$V_{CC}$	18	V	
DC Supply Voltage	$V_{CC(DC)}$	26	V	1
Peak Supply Voltage	$V_{CC(peak)}$	50	V	
Output Current per Channel	$I_o$	4	A	
Power Dissipation	$P_T$	15	W	2
Thermal Resistance (Junction-Case)	$\theta_{j-c}$	3	$^\circ\text{C/W}$	
Junction Temperature	$T_j$	150	$^\circ\text{C}$	
Operating Temperature	$T_{opr}$	-20 to +70	$^\circ\text{C}$	
Storage Temperature	$T_{stg}$	-55 to +125	$^\circ\text{C}$	

Notes: 1. Value at 30sec    2. Pulse Width = 200ms,  $t_r \geq 1\text{ms}$

### ■ ELECTRICAL CHARACTERISTICS ( $T_a = 25^\circ\text{C}$ , $V_{CC} = 13.2\text{V}$ , $f = 1\text{kHz}$ , $R_L = 4\Omega$ )

#### ● ONE-HALF OPERATION

Item	Symbol	Test Condition	min.	typ.	max.	Unit	
Quiescent Current	$I_Q$	$V_i = 0$	—	80	160	mA	
Input Bias Voltage	$V_B$	$V_i = 0$	—	—	40	mV	
Voltage Gain	$G_V$	$V_i = 2.45\text{mV}$	53	55	57	dB	
Difference of Voltage Gain	$\Delta G_V$	$V_i = 2.45\text{mV}$	—	—	$\pm 1.5$	dB	
Output Power per Channel	$P_{out}$	$R_L = 4\Omega$ $THD = 10\%$	$V_{CC} = 13.2\text{V}$	5.0	5.8	—	W
			$V_{CC} = 14.4\text{V}$	—	7.0	—	
Total Harmonic Distortion	$THD$	$P_{out} = 0.5\text{W}$	—	0.15	1.0	%	
Noise Output	$WBN$	$R_g = 10\text{k}\Omega$ , $BW = 20\text{Hz to } 20\text{kHz}$	—	1.0	2.0	mV	
Supply Voltage Rejection Ratio	$SVR$	$R_g = 600\Omega$ , $f = 500\text{Hz}$	30	40	—	dB	
Input Resistance	$R_{in}$	$f = 1\text{kHz}$	—	30	—	$\text{k}\Omega$	
Rolloff Frequency	$f_L$	$G_V = -3\text{dB from}$ $f = 1\text{kHz Ref.}$	Low	—	40	—	Hz
	$f_H$		High	—	25	—	kHz
Cross-talk	$CT$	$f = 500\text{Hz}$ , $R_g = 600\Omega$	40	58	—	dB	

#### ● DUAL OPERATION

Output Power per Channel	$P_{out}$	$THD = 10\%$ , $R_L = 4\Omega$	—	5.6	—	W
Total Harmonic Distortion	$THD$	$P_{out} = 0.5\text{W}$	—	0.15	—	%

■ TYPICAL APPLICATION

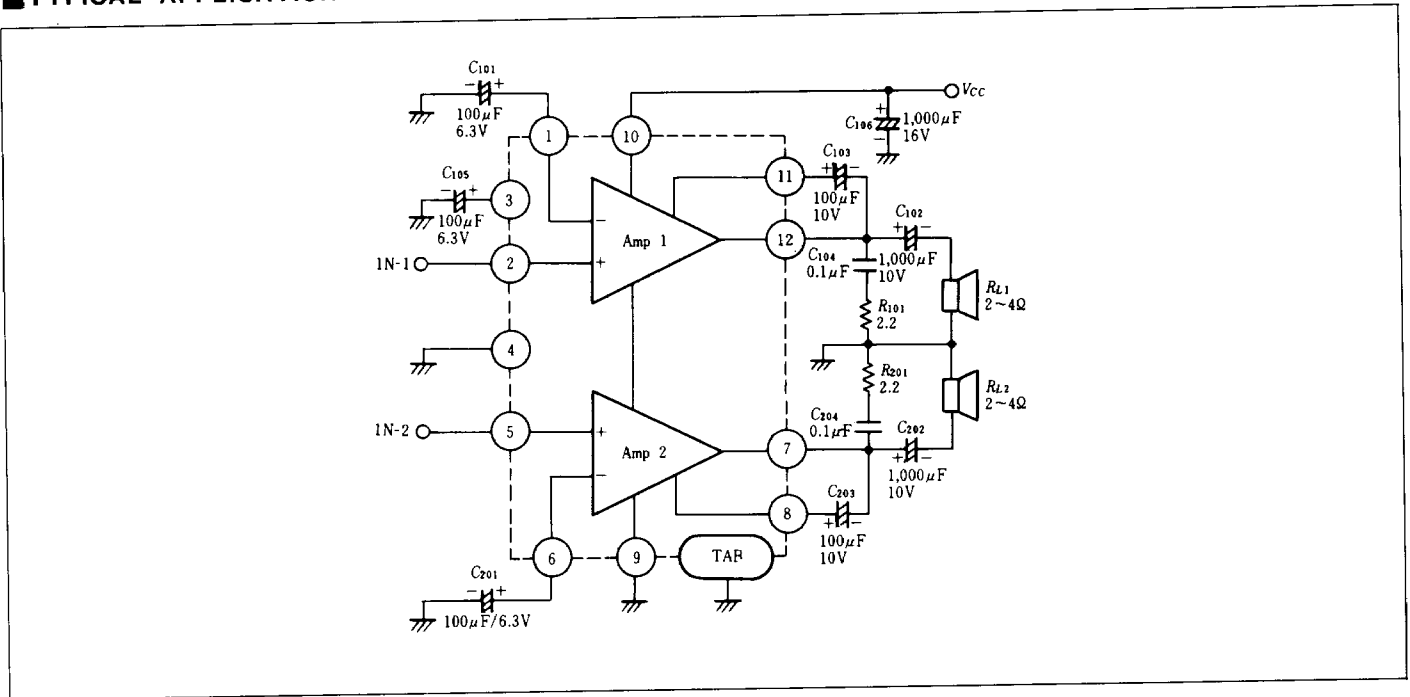

■ PC-BOARD LAYOUT PATTERN

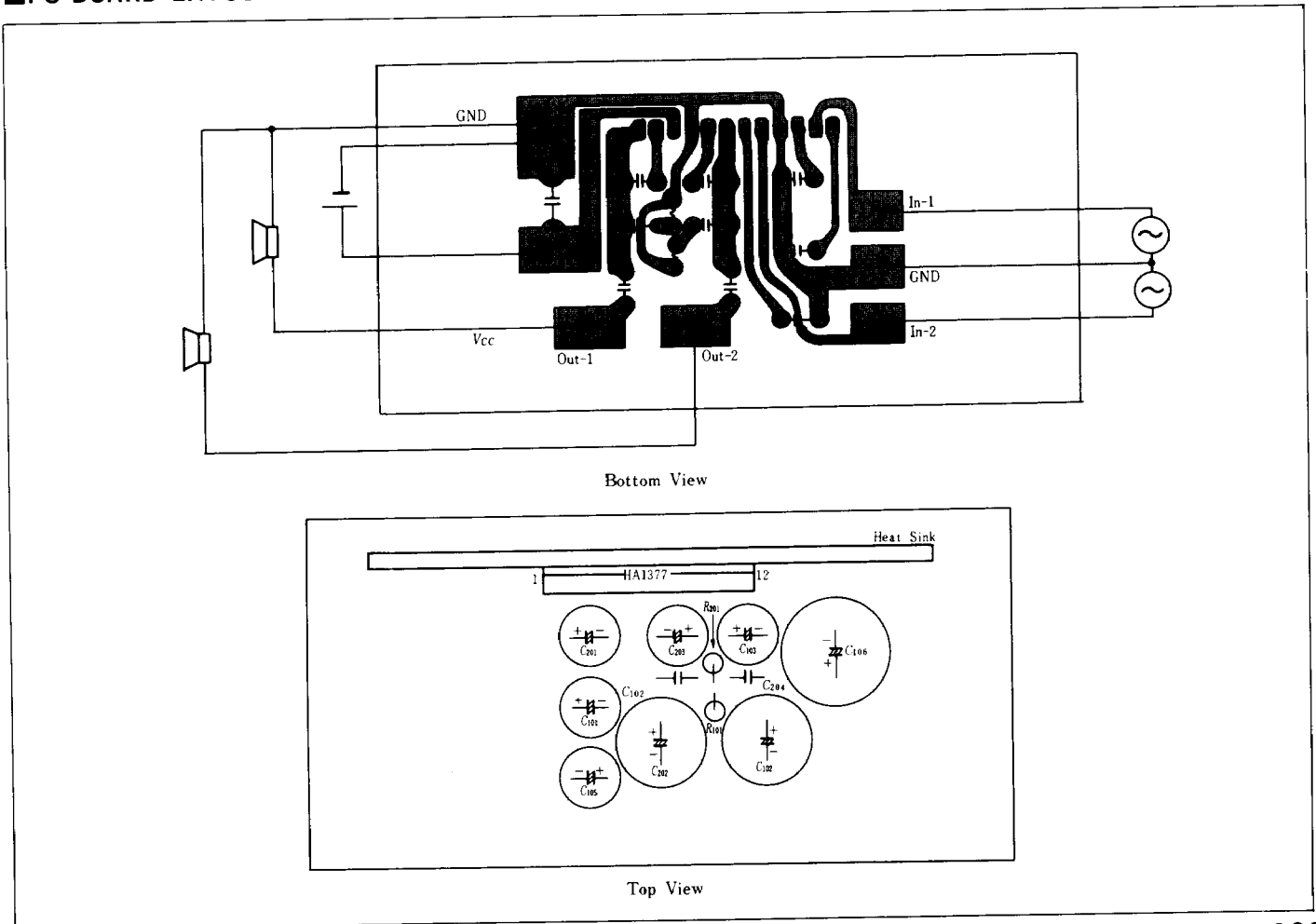

EXTERNAL COMPONENTS

Parts No.	Recommended value	Purpose	Larger than recommended value	Smaller than recommended value
$C_{101}, C_{201}$	100 $\mu$ F	Inverting DC decoupling		Higher low frequency rolloff
$C_{102}, C_{202}$	1000 $\mu$ F	Output coupling to load	Danger of burn-out	Higher low frequency rolloff
$C_{103}, C_{203}$	100 $\mu$ F	Boot strap	Danger of burn-out at load dump surge	Smaller power bandwidth
$C_{104}, C_{204}$	0.1 $\mu$ F	Frequency stability	Increase of drain current at high frequency	Danger of oscillation
$C_{105}$	100 $\mu$ F	Ripple rejection		Pop sound at switch-on
$C_{106}$	1000 $\mu$ F	Supply bypassing		Danger of oscillation
$R_{101}, R_{201}$	2.2 $\Omega$	Frequency stability	Danger of oscillation	Danger of oscillation

TOTAL HARMONIC DISTORTION VS. OUTPUT POWER

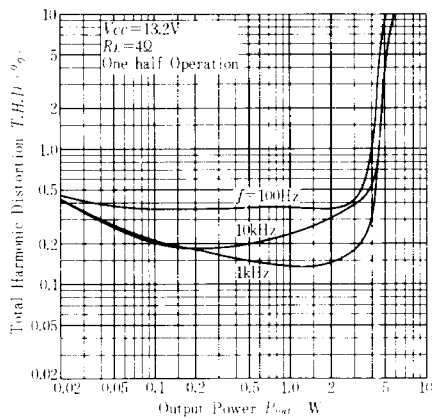

TOTAL HARMONIC DISTORTION VS. FREQUENCY

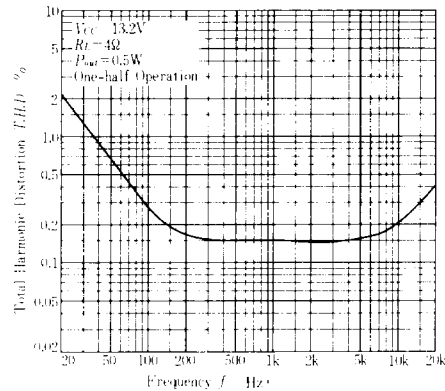

OUTPUT POWER VS. SUPPLY VOLTAGE

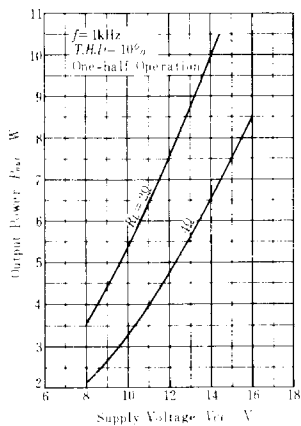

OUTPUT POWER VS. LOAD RESISTANCE

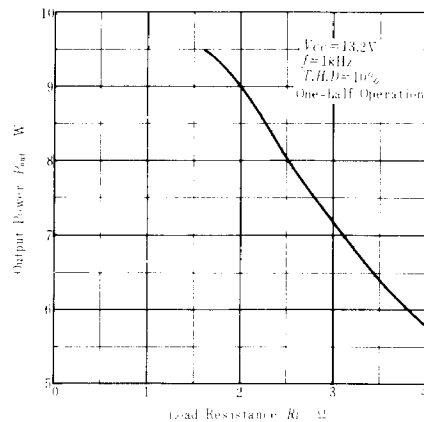

OUTPUT POWER VS. FREQUENCY

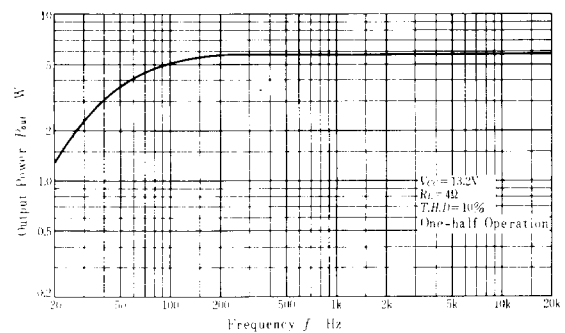

**RELATIVE VOLTAGE GAIN VS. FREQUENCY**

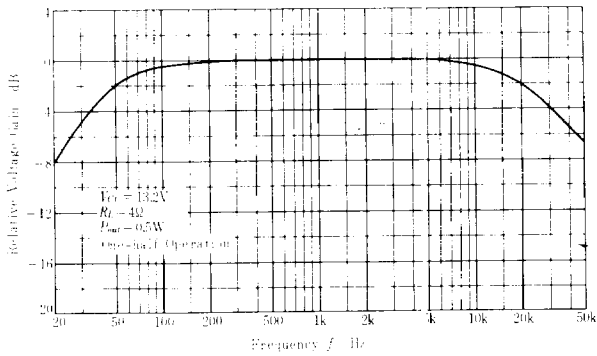

**NOISE OUTPUT VS. SIGNAL SOURCE RESISTANCE**

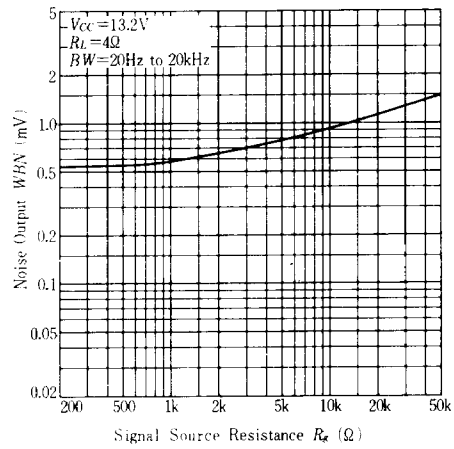

**SUPPLY VOLTAGE REJECTION RATIO VS. FREQUENCY**

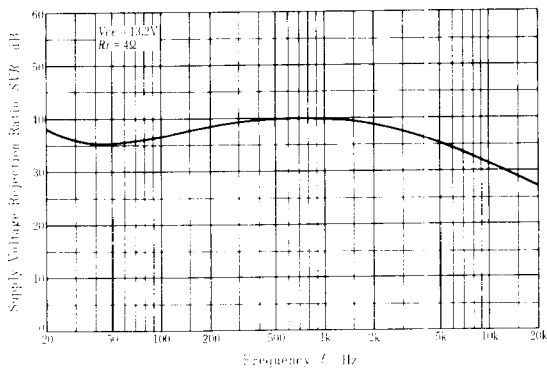

**CROSS-TALK VS. FREQUENCY**

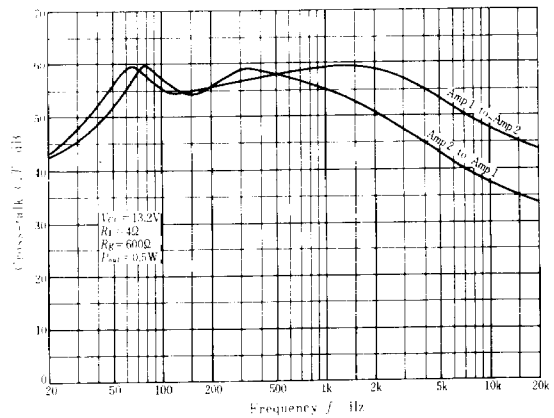

**POWER DISSIPATION VS. OUTPUT POWER**

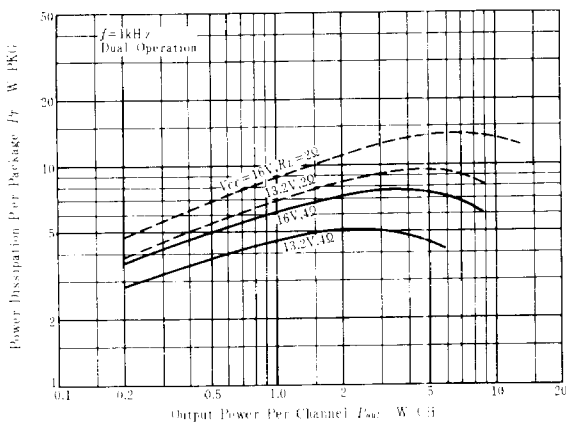

**QUIESCENT CURRENT VS. SUPPLY VOLTAGE**

